

# ELB-5466

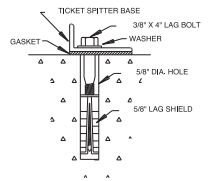

TD-249 & TD-256  
TICKET SPITTERS

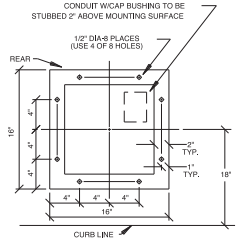
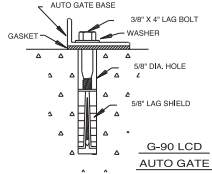
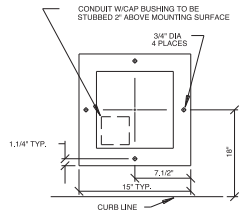
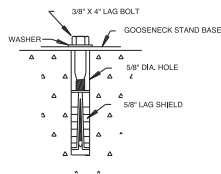
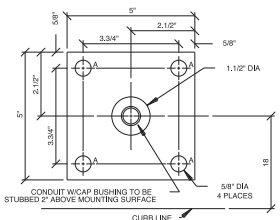

GOOSENECK STAND

ALL AC POWER RUNS SHALL CONSIST OF THREE WIRES:

- 1 - HOT
- 1 - NEUTRAL
- 1 - GROUND CONDUCTOR

THE GROUND CONDUCTOR SHALL BE PULLED FROM THE SERVICE PANEL.

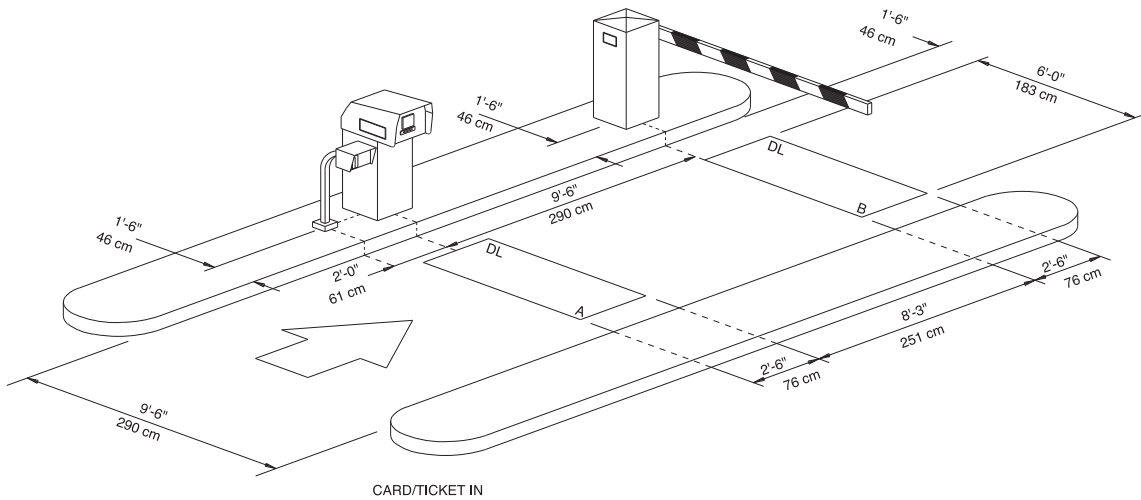

### EQUIPMENT LEGEND

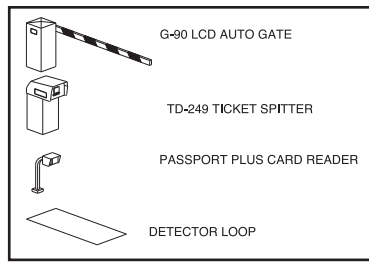

ALL CONDUIT, INCLUDING LOOP LEAD IN, MUST STUB UP 2"-3" (50.8mm-76.2mm) ABOVE EQUIPMENT MOUNTING SURFACE.

ALL DETECTOR LOOPS SHALL HAVE 5 TURNS UNLESS OTHERWISE NOTED AND SHALL NOT BE INSTALLED ACROSS LATERAL EXPANSION OR CONSTRUCTION JOINTS.

**\*\* CAUTION \*\***  
CONTROL AND POWER RUNS MUST BE 18" (0.46m) MINIMUM AWAY FROM DETECTOR LOOPS.

FEDERAL APD WILL NOT BE LIABLE FOR ANY MISINFORMATION REGARDING EQUIPMENT NOT SUPPLIED BY FEDERAL APD.

POWER CURRENT SPECIFICATIONS: THE POWER CIRCUIT WIRE GAUGE SHALL BE CAPABLE OF CONTINUOUSLY SUPPLYING THE SPECIFIED CURRENT AT THE LOCATION OF THE EQUIPMENT AND MAINTAIN 115VAC +OR- 3% AT LOAD.

POWER WIRES MUST BE 90 DEGREES C - 194 DEGREES F.

NOTE:  
A - CONDUIT AREA - STUB 2" (50.8 mm) ABOVE SURFACE.  
B - HOLES 3/4" (19.1mm) DIA  
\* - CENTER LINE OF CASHIERING POINT.

**CAUTION**  
AUTOS ONLY  
NO MOTORCYCLES, BICYCLES  
OR PEDESTRIANS



42775 Nine Mile Rd. • Novi, Michigan 48735 • Tel: (248) 374-9600 • Fax: (248) 374-9610

This drawing and all information contained thereon is confidential and the property of FEDERAL APD. It may not be reproduced in whole or in part without expressed written consent. This document is loaned subject to return upon demand. It may not be used directly or indirectly for purposes detrimental to the interests of FAPD.

PROJECT: CARD/TICKET IN			DESC: EQUIPMENT LAYOUT			
SCALE: NONE	DATE: 06/27/97	DWG BY: JEN	FAPD W.O.#	DRAWING # ELB-5466		